

LILY BEARING

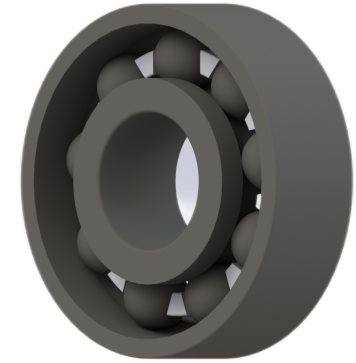

b:	25°		Contact Angle
R <sub>3,4</sub> :	min 0.6	mm	Chamfer Dimension
R <sub>1,2</sub> :	min 1.5	mm	Chamfer Dimension
D1:	174.6	mm	Shoulder Dia Of Outer Ring
d1:	155.4	mm	Shoulder Dia Of inner Ring
a:	45.8	mm	Distance From Side Face To Pressure Point

**LILY**<sup>®</sup>

SHANGHAI LILY BEARING LIMITED

Email: [lilybearing@lily-bearing.com](mailto:lilybearing@lily-bearing.com)

Part  
Number

CE71928SC  
Ceramic Angular Contact Ball Bearings