

LILY BEARING

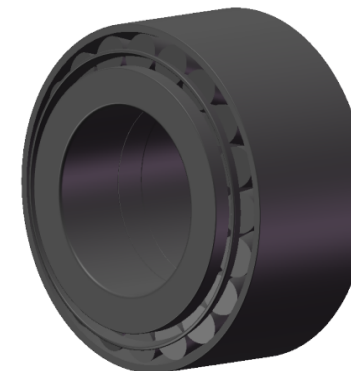

- d1: 572 mm Dia Of Shaft Abutment
- a: 256 mm Distance Between Pressure Point
- R1: 1.5 mm Chamfer Dimension Of Outer Ring
- R2: 6.4 mm Chamfer Dimension Of Inner Ring

LILY[®]

SHANGHAI LILY BEARING LIMITED

Email: lilybearing@lily-bearing.com

Part
Number

331657 Double row tapered roller bearing