

LILY BEARING

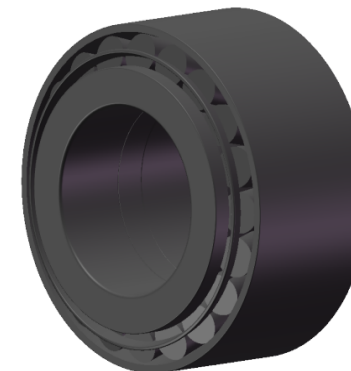

d1:	357	mm	Dia Of Shaft Abutment
a:	162	mm	Distance Between Pressure Point
R1:	1.5	mm	Chamfer Dimension Of Outer Ring
R2:	6.4	mm	Chamfer Dimension Of Inner Ring

LILY[®]

SHANGHAI LILY BEARING LIMITED

Email: lilybearing@lily-bearing.com

Part
Number

BT2B-332504-HA2 Double row tapered roller bearing